

# INSTALLATION AND OPERATING INSTRUCTIONS

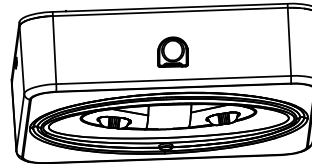

## MAINS POWERED BATTERY BACK UP EMERGENCY LUMINAIRE

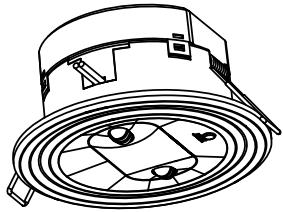

**Recessed LED Downlight Cautions: The luminaire is not suitable for covering with thermally insulated material.**

### CAUTIONS

The luminaire shall, under no circumstances, be covered with insulating material or similar material only EMD/R. Replace the battery when the battery no longer meets its rated duration of operation (see the label of battery replacing).

### GENERAL INFORMATION

LED emergency light, down light style, have self-contained lighting, for pathway and door light used optional.

LED light source provides low power consumption and long life.

Enclosure is made by polycarbonate, recessed mounting or surface mounting.

### TECHNICAL DATA

Power Supply	: 220-240VAC, 50 Hz
Power Consumption	: Max. 6.5W
Operation	: Maintained or Non maintained
Function	: Manual test or Auto test optional
Duration	: Discharge 1H or 3H
Charge time	: 24h
Protection grade	: IP20
Emergency lumens output	: 1H/180lm 3H/120lm
Light distribution	: Path way (Standard) : Door way (Optional)

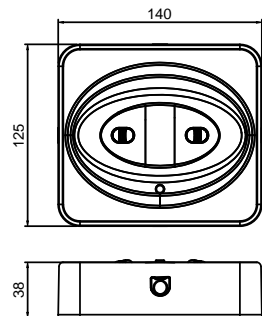
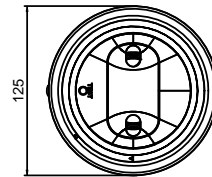
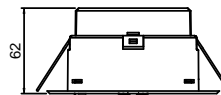

### PRECAUTIONS

This product should be installed by a registered electrician in accordance with local standards and electrical regulations. Take care to ensure the mains supply is isolated before installation. Check the unit label for correct supply voltage and frequency.

### SERVICE & OPERATION

**Normal Operation:** The green indicator light on the bottom unit stays on. The LED will go out if the mains supply fails, if the internal charger is malfunctioning, or if the unit is in test mode. The fixture must be charge 24 hours after installation.

**Battery:** Sealed Nickel-Cadmium rechargeable battery pack. Batteries of a different type must not be used. Batteries should be replaced by authorised service personnel only. If the unit no longer maintains its rated battery backup test times. Should only be replaced by competent service personnel with manufacturers battery pack. Old Batteries should be recycled.

**Test Switch:** If pressed the test switch, LED indicator will go out and the fixture will operate from its battery supply.

### INSTALLATION

(EMD/R)

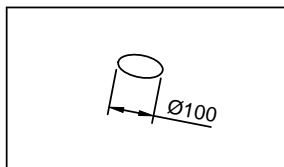

- ① Cut out mounting hole in ceiling, hole dimension is 100mm.

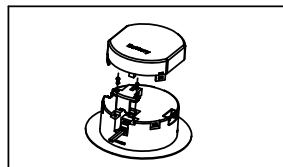

- ② Remove battery pack from housing, remove cable locker.

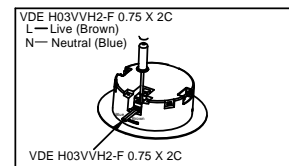

- ③ Feed the power cable through the mounting hole and connect to terminal block on fixture.

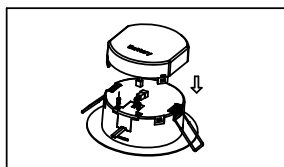

- ④ Fixed cable locker. Connect battery connector, Snap battery pack on housing.

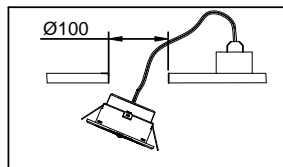

- ⑤ Snap fixture with spring into mounting hole.

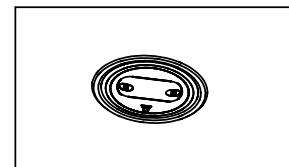

- ⑥ Press the test switch, indicator will go out, emergency light will light on.

## (EMD/S)

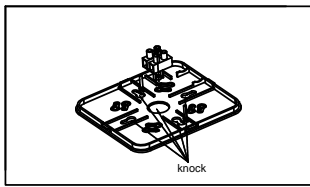

① Open fixture, knock out center hole on back plate.

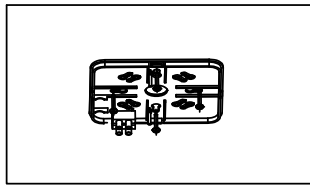

② Install back plate on appropriate ceiling surface.

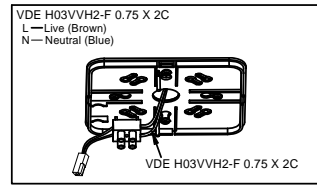

③ Feed the power cable through the knock hole and connect to terminal block on fixture.

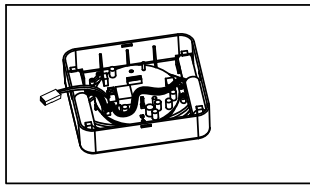

④ Connect battery connector.

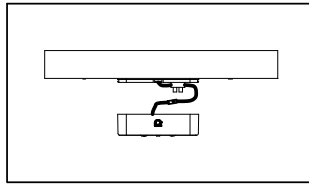

⑤ Snap fixture housing ass'y on back plate. Restore power supply.

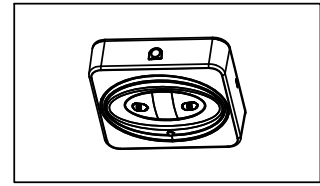

⑥ Press the test switch, indicator will go out, emergency light will light on.

## TECHNICAL INFORMATION

Model Number	Input Voltage	Charge Duration	Discharge Duration	Operation	Battery	Power	LED
EMD/1H/AT/M/R EMD/1H/AT/M/S	220-240V~ 50Hz	24h	1 h	Maintained	Ni-Cd,7.2V 800mA	6.5W	3W LED 2pcs
EMD/3H/AT/M/R EMD/3H/AT/M/S	220-240V~ 50Hz	24h	3 h	Maintained	Ni-Cd,7.2V 1000mA	4.8W	3W LED 2pcs
EMD/1H/MT/M/R EMD/1H/MT/M/S	220-240V~ 50Hz	24h	1 h	Maintained	Ni-Cd,7.2V 800mA	6W	3W LED 2pcs
EMD/3H/MT/M/R EMD/3H/MT/M/S	220-240V~ 50Hz	24h	3 h	Maintained	Ni-Cd,7.2V 1000mA	4.5W	3W LED 2pcs
EMD/1H/AT/NM/R EMD/1H/AT/NM/S	220-240V~ 50Hz	24h	1 h	Non-Maintained	Ni-Cd,7.2V 800mA	2.4W	3W LED 2pcs
EMD/3H/AT/NM/R EMD/3H/AT/NM/S	220-240V~ 50Hz	24h	3 h	Non-Maintained	Ni-Cd,7.2V 1000mA	2.4W	3W LED 2pcs
EMD/1H/MT/NM/R EMD/1H/MT/NM/S	220-240V~ 50Hz	24h	1 h	Non-Maintained	Ni-Cd,7.2V 800mA	1.6W	3W LED 2pcs
EMD/3H/MT/NM/R EMD/3H/MT/NM/S	220-240V~ 50Hz	24h	3 h	Non-Maintained	Ni-Cd,7.2V 1000mA	1.6W	3W LED 2pcs

## Maintained and Non-Maintained function

- Maintained : Assemble wire connector
- Non - Maintained : Disassemble wire connector

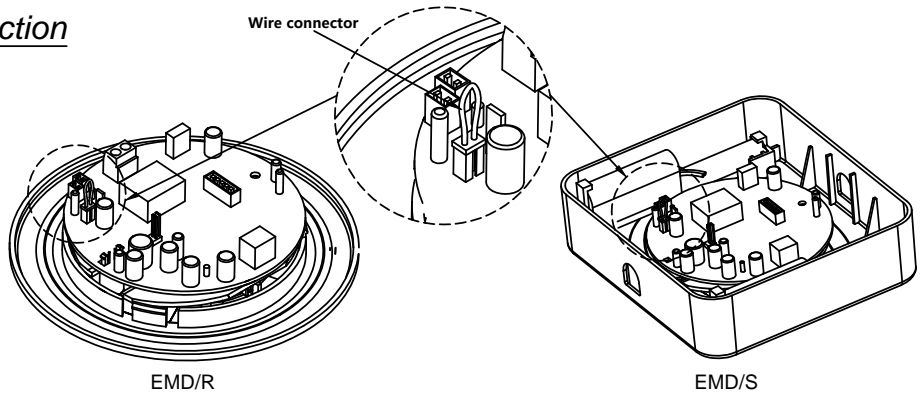

## PHOTOMETRIC

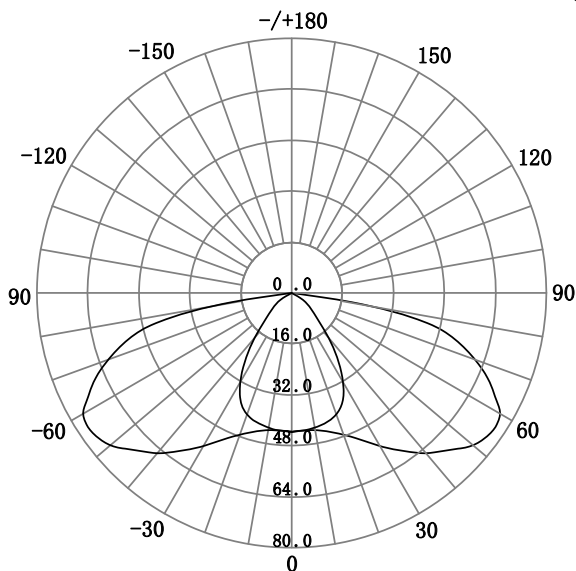

EMD Narrow Lens (Path Way)

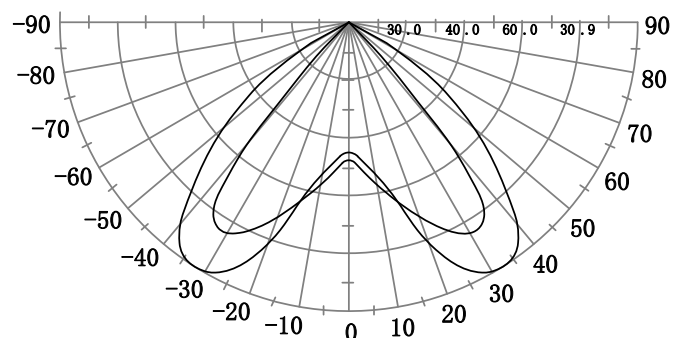

EMD Wide lens (Door Way)

# INSTRUCTIONS FOR AUTO TEST

1. **Install luminaire according to installation instruction sheet**
2. **Once the unit is powered up it will automatically initiate a self test and diagnostics as follows:**

- Every month : Performs a 3 minute duration test
- Every year : Performs a 1 Hour or 3 Hour duration test

All test functions are factory preset and do not need field adjustment

### 3. **Dual color indicator LED status Meanings**

- Green      Solid On      Ready / Normal Operation  
                  Flashing      Testing
- Red          Requires Service

●	One flash, 4 second pause	Battery is not connected
● ●	Two flashes, 4 second pause	Battery short or low battery voltage
● ● ●	Three flashes, 4 second pause	Charger board circuit fault
● ● ● ●	Four flashes, 4 second pause	Transformer power fault

### **NOTE**

After repairing a service fault, press and hold the test button for 2 seconds to reset the flashing indicator light to green

### 4. **Manual Testing**

Press test button once	30 seconds duration test
Press test button twice within 2 seconds	3 minutes duration test
Press test button 3 times within 2 seconds	30 minutes duration test
Press test button 4 times within 2 seconds	1 or 3 hours duration test