



RZ STELLA 2 16 DA duo, PLC

PLC
24

Deckenaufbaugehäuse, IP40, mit separat schaltbarer SL

Eigenschaften / Technische Daten:

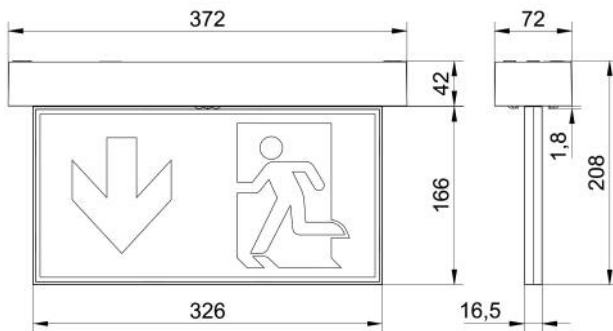

Masse in mm

Artikelnummer:	L04.100658
Gewicht:	1,15 kg
Zertifikate:	CE

Gehäuse:	Polycarbonat, flammhemmend	Farbe Gehäuse:	RAL 9003 Signalweiss
Wirkleistung DC 24V:	2,9 W	Nennleistung Leuchtmittel:	0,7 W / 1,1 W (SL)
Scheibe:	PMMA mit scheibeninterner Lichtlenkung	Leuchtmittel:	Mid- und High-Power-LEDs
Schutzklasse:	II	Bestromung Leuchtmittel:	115 mA / 350 mA (SL)
IP-Schutz:	IP40	Nennlichtstrom Leuchtmittel:	125 lm / 160 lm (SL)
IK Stossfestigkeitsgrad:	IK03	Netzanschlussklemme:	2 x 3 x 2,5 mm ²
Temperaturbereich:	ta: -15°C..+40°C	Überwachungsart:	PLC24
Farbwiedergabeindex:	Ra 80	Eingangsspannung DC:	24 V DC +/-20%
Erkennungsweite:	32 m		

Abstandstabelle/Lichtverteilungskurve:

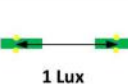
Montagehöhe [m]				
2,5	5,9	13,1	4,6	1,3
3,0	6,6	14,9	4,4	1,1
3,5	7,2	16,6	3,9	1,2
4,0	7,6	18,2	3,2	1,2
4,5	7,7	19,5	3,2	1,3

RZ STELLA 2 DA/DE duo ||

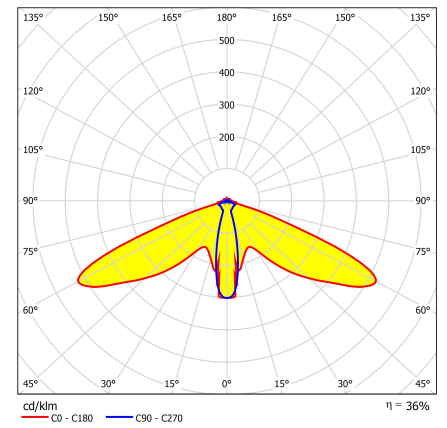

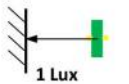
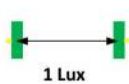
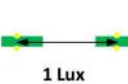
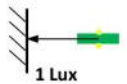
Montagehöhe [m]				
2,5	0,9	4,5	11,9	5,0
3,0	0,8	3,2	13,2	5,4
3,5	0,8	2,5	14,3	5,6
4,0	0,9	2,3	15,1	5,6
4,5	0,9	2,3	15,6	5,7

RZ STELLA 2 DA/DE duo --

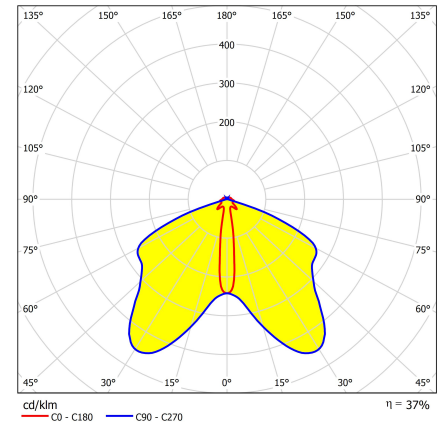

Zubehör / Scheiben:

L04.100651 | Piktogrammscheibe STELLA 2.16, DA/DE, PL | Erkennungsweite 32m, ISO 7010 (Masse in mm)

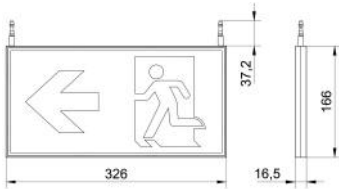

L04.100652 | Piktogrammscheibe STELLA 2.16, DA/DE, PR | Erkennungsweite 32m, ISO 7010 (Masse in mm)

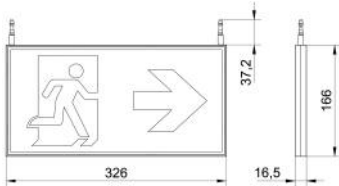

L04.100653 | Piktogrammscheibe STELLA 2.16, DA/DE, PU | Erkennungsweite 32m, ISO 7010 (Masse in mm)

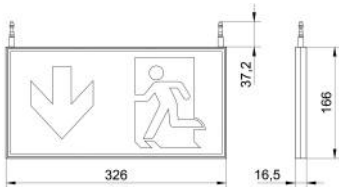

L04.100654 | Piktogrammscheibe STELLA 2.16 DA/DE, PL/PR | Erkennungsweite 32m, ISO 7010 (Masse in mm)

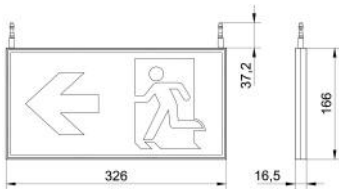

L04.100665 | STELLA 2 Pendelset 0,5m | hochglanzverchromt, für STELLA 2 Deckenaufbau-/ einbau (Masse in mm)

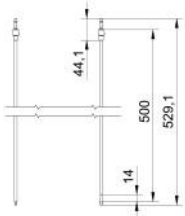

L04.100666 | STELLA 2 Pendelset 1,0m | hochglanzverchromt, für STELLA 2 Deckenaufbau-/ einbau (Masse in mm)

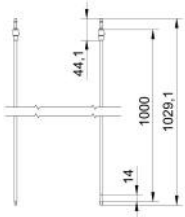

L04.100667 | STELLA 2 Seilmontageset 1,5m | für STELLA 2 Deckenaufbau-/ einbau (Masse in mm)

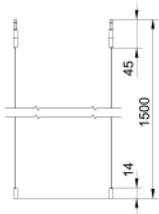

L04.100668 | STELLA 2 Seilmontageset 4,0m | für STELLA 2 Deckenaufbau-/ einbau (Masse in mm)

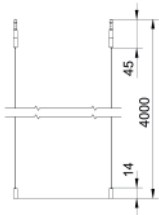

L04.100669 | STELLA 2 Aufpreis Aludesign | je Artikel

L04.100670 | STELLA 2 Aufpreis Farbe RAL nach Wahl | Angabe RAL Farbe erforderlich, je Artikel

Ersatzteile:

L04.100709 | STELLA 2 Gehäuseblende Gr.3 mit 2xSL | Ersatzteil für STELLA 2 DA/DE duo/plus Gehäuse Gr.3

L04.100716 | STELLA Elektronik LCU-S-PLC24-G1G3 | 115mA - 350mA LED Elektronik, eckig, im Gehäuse