

Chain Fastening

Compatible with FlexiTech EC & CC, 20M & 30M

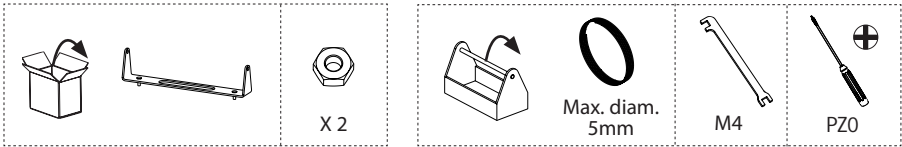

1

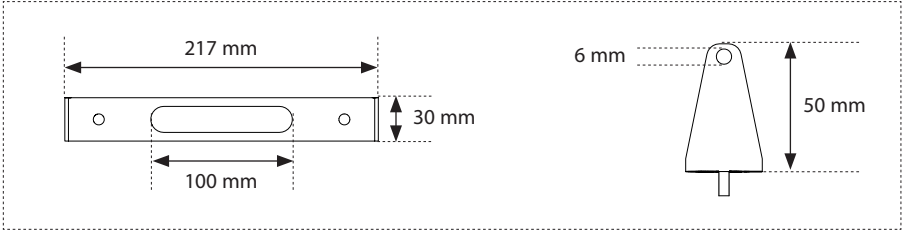

a

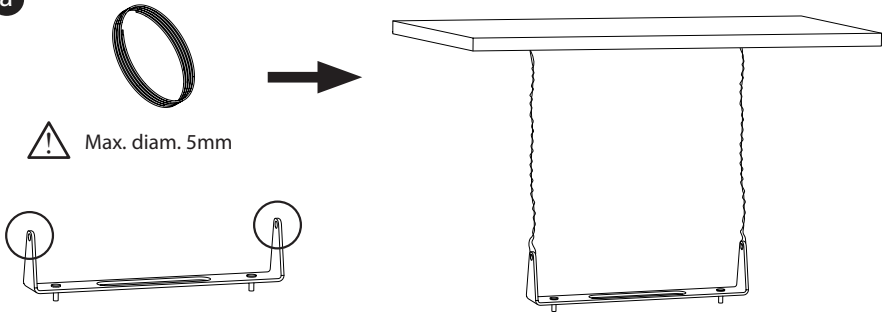

b

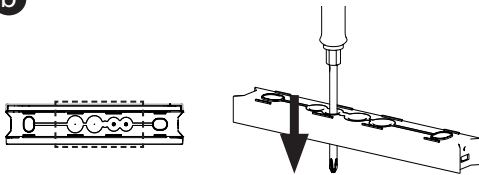

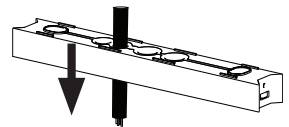

c



Powering Business Worldwide

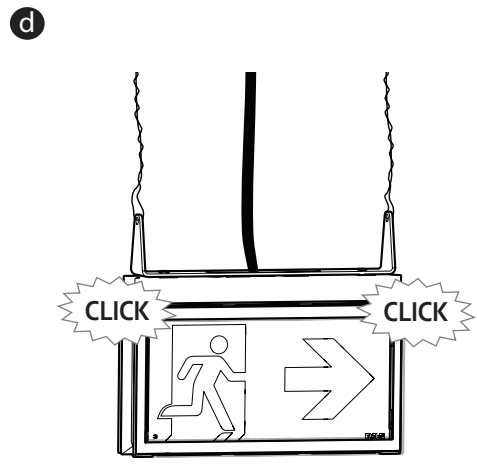
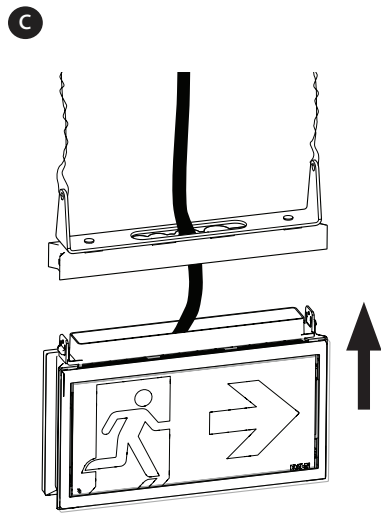
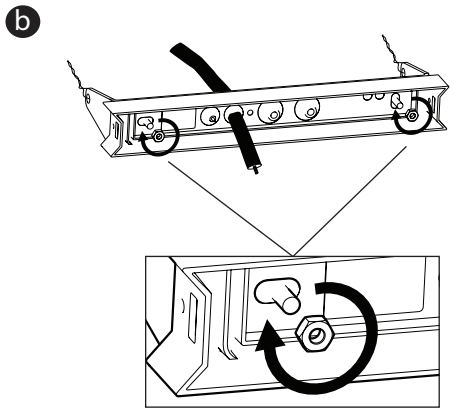
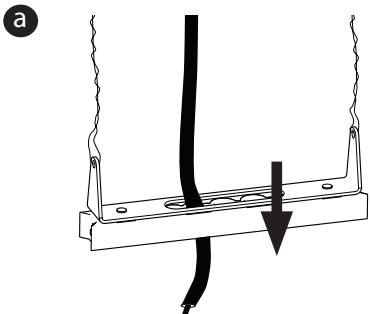



 Please refer to the luminaire manual for more information regarding installation and cabling.

3

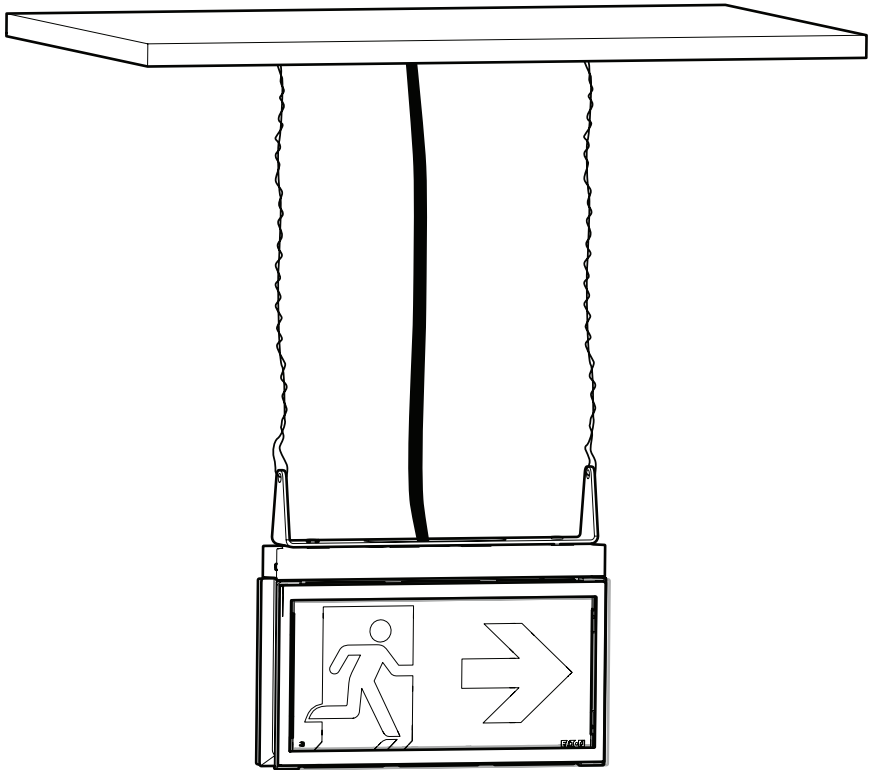

EATON

Powering Business Worldwide

Eaton
Cooper Sécurité SAS
PEE II - Rue Beethoven - BP10184
63204 RIOM CEDEX FRANCE
Tél. +33 (0)825 826 212 (0,15 € TTC/min)
www.cooperfrance.com
www.eaton.com

© 2022 Eaton
All Rights Reserved

ZNO2062900 A - 03/2022

Eaton is a registered trademark.

All trademarks are property
of their respective owners.



WEEE: Contact your local dealer

Eaton.com/recycling

