

Recessed Kit FlexiTech

Compatible with FT3 EW & FT3 SU

Cadre encastrément / Deckeneinbau-Kit

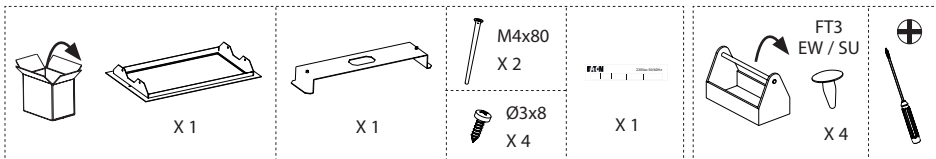
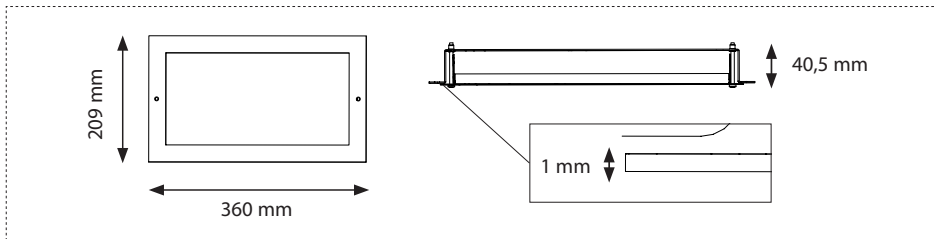
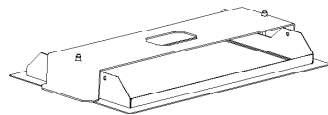

1

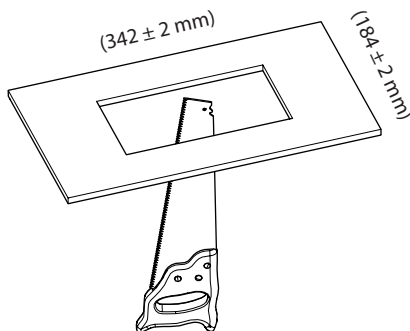
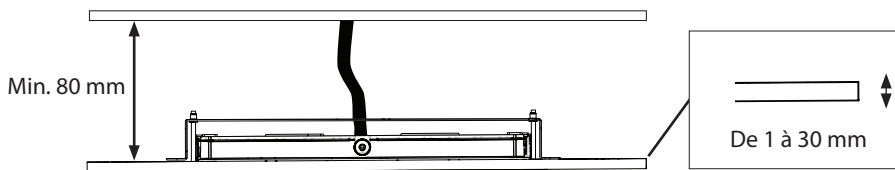

Powering Business Worldwide

2

a

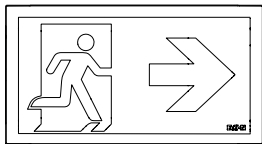

FT3 EW / FT3 SU

b



EATON 2101B FlexiTech 30m - FT3EW4ICGL 18 P43 IK07
 COOPER SECURITE SAS 230V~ / 50-60HZ IM : ta: 0-45°C 5.5VA/2.5W
 63200 RIOM Made in Romania Li 3.2V 1.5Ah NM : ta: 5-45°C 1VA/0.3W



3

a

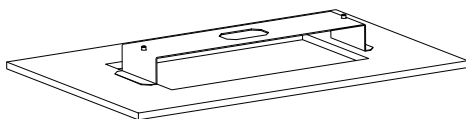
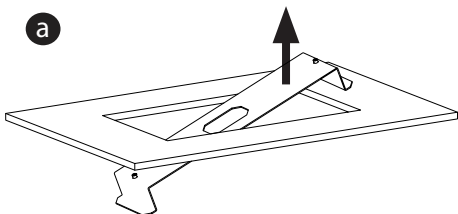

b

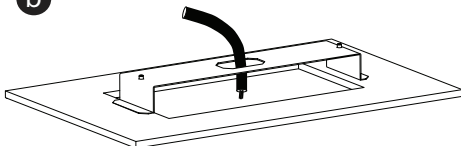

c

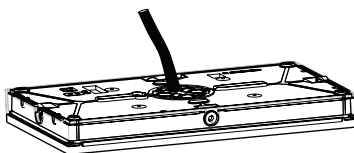

See FT3 EW/SU user manuals for cabling and complete installation of the luminaire.

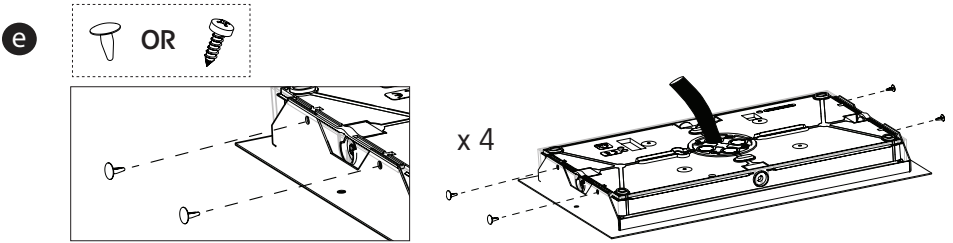
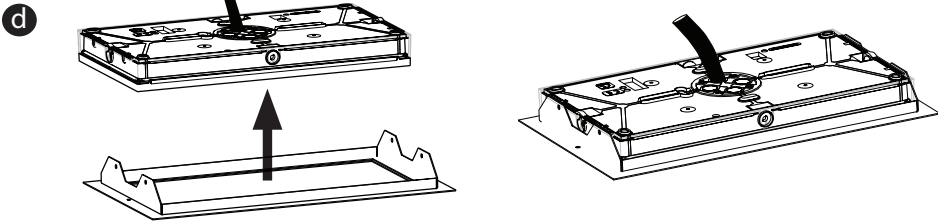
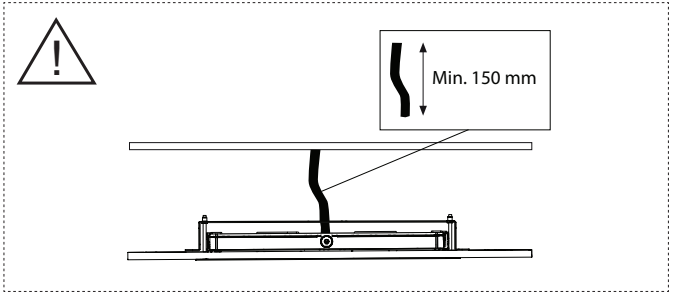

4

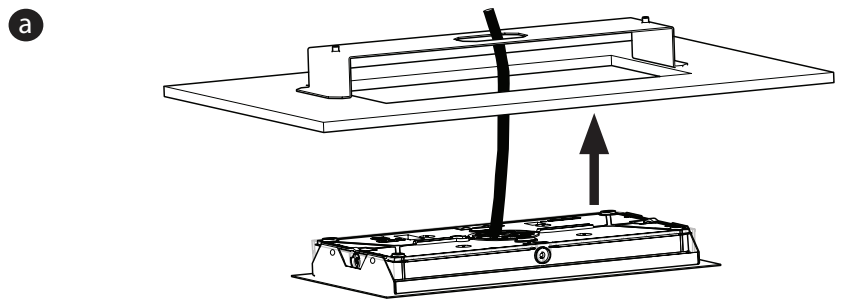

b

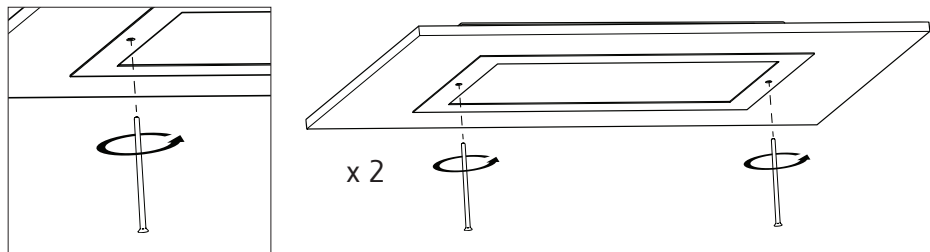

c

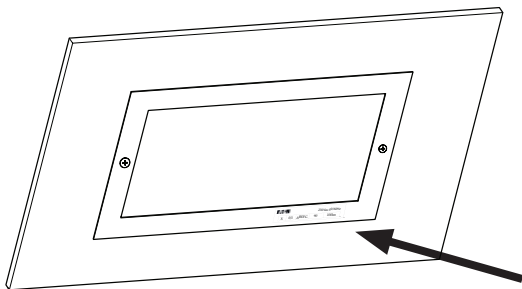

| | | | | |
|--------------|-----|-------|----------------|-------|
| EAT•N | | | 230Vac 50/60Hz | |
| X | 0/1 | ABEFG | 90 | 100lm |

Eaton
 Cooper Sécurité SAS
 PEE II - Rue Beethoven - BP10184
 63204 RIOM CEDEX FRANCE
 Tél. +33 (0)825 826 212 (0,15 € TTC/min)
 www.cooperfrance.com
 www.eaton.com

Eaton
 EMEA Headquarters
 Route de la Longeraie 7
 1110 Morges, Switzerland
 Eaton.eu

© 2022 Eaton
 All Rights Reserved

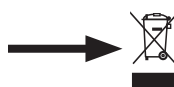
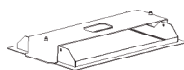

WEEE: Contact your local dealer
Eaton.com/recycling

ZNO2063500 A - 03/2022

Eaton is a registered trademark.

All trademarks are property
 of their respective owners.

EAT•N

Powering Business Worldwide

