

SIMPLEMENT 2 SY 3 DA, PLC

Deckenaufbauleuchte mit symmetrischer Optik für Montagehöhen bis 7 m, inkl. LED-Versorgung.
Zulassungszeichen schockgeprüfte Sicherheitsleuchte: BZS S 20-311.

Artikelnummer	L04.101017
Temperaturbereich	-15°C – 40°C
Gehäusematerial	Polycarbonat, feuerhemmend, UV-stabilisiert
Gehäusefarbe	Signalweiss (RAL 9003)
Anschlussspannung DC	24 V ± 25 %



Technische Spezifikationen

ELEKTRO

Wirkleistung 1,3 W

LICHT

Optik symmetrisch

Lichstrom Φ Nenn 187,5 lm

MECHANIK

Anschlussklemmen 2 x 3 x 2,5 mm²

Scheibenmaterial optional, Material: PMMA

Abmessungen (HxBxT) 64,5 x 340 x 65 mm

Gewicht 0,47 kg

- Die Leuchte ist gem. EN 60598-2-24 zur Verwendung in Umgebungen geeignet, welche in IEC 60364-4-42 festgelegt sind.
- Zubehörteile, welche die Schutzart IP65 vermindern, dürfen aufgrund der Anforderung der „D“ Kennzeichnung gem. EN 60598-2-24 nicht verwendet werden.
- Diese Leuchte ist für Temperaturbereiche im Aussenbereich der gemässigten Klimazone Mitteleuropas geeignet.

Weitere Bilder

Montagevariante



Montagevariante



Montagevariante

 Technische Informationen

Technische Zeichnung

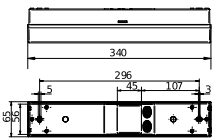

Technische Zeichnung

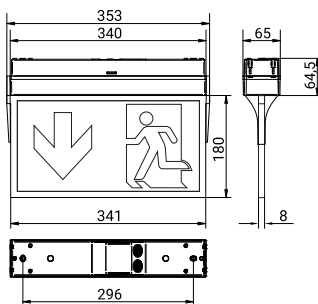
 Zubehör



Piktogramm SIMPLEMENT 16, PL

L04.100432



Piktogramm SIMPLEMENT 16, PR

L04.100433



Piktogramm SIMPLEMENT 16, PU

L04.100434



Piktogramm SIMPLEMENT 16, PL/PR

L04.100435



Piktogramm SIMPLEMENT 16, PARAMETER

L04.100775



Piktogramm SIMPLEMENT 16, ISO 7010

L04.100790

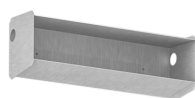

SIMPLEMENT Beton

L04.100459



SIMPLEMENT UP

L04.100460

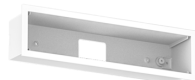

SIMPLEMENT DE/WE

L04.100458



SIMPLEMENT WA-PP-G Kunststoff

L04.100440



SIMPLEMENT Beilagscheiben

L04.100441



SIMPLEMENT WA-PP

L04.100438



SIMPLEMENT WA-PP-G

L04.100439



SIMPLEMENT WA-PP-G Nirosta

L04.100442



SIMPLEMENT WA-90

L04.100443



SIMPLEMENT WA-90 Nirosta

L04.100444



SIMPLEMENT MA-G

L04.100445



SIMPLEMENT-MA-G Nirosta

L04.100446



Stahlseil-Abhängung

L04.100456



SIMPLEMENT BE

L04.100457



SIMPLEMENT VP

L04.100455



Ballschutzkorb 1

L04.100461

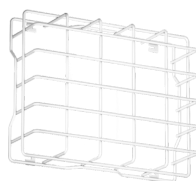

Ballschutzkorb 2

L04.100462



SIMPLEMENT SA

L04.100466



SIMPLEMENT RD

L04.100463



SIMPLEMENT SG, PLC

L04.100465



SIMPLEMENT-WA Schraubset

L04.100788

Ersatzteile



LCU-A-PLC24 115mA

L04.100485



SIMPLEMENT Montageteil PLC

L04.100469

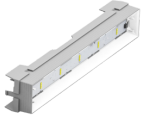

SIMPLEMENT 2 SY 3, PLC Einsatz + EVG

L04.101031



SIMPLEMENT Haube H30 transparent

L04.100473



SIMPLEMENT 2 LED-Platine SY/AS/TS

L04.100487



SIMPLEMENT Scheibenhalter

L04.100474



SIMPLEMENT Clip

L04.100475



SIMPLEMENT Dichtungsstopfen

L04.100476

Abstandstabelle

Deckenmontage
symmetrisch

Montagehöhe in
Meter

L1



L2



L3



L4



L5



2,0

3,2

8,0

3,1

6,8

7,3

2,5



3,5

8,8

3,6

8,1





8,3

Montagehöhe in Meter	L1	L2	L3	L4	L5
					
3,0	3,7	9,4	3,8	9,0	9,1
3,5	3,8	9,9	3,9	10,0	9,8
4,0	3,8	10,3	3,8	10,5	10,4
4,5	3,8	10,5	3,7	10,8	10,7
5,0	3,6	10,7	3,6	10,9	10,8
5,5	3,5	10,8	3,4	10,7	10,7
6,0	3,2	10,7	3,1	10,6	10,7
6,5	2,8	10,6	2,7	10,5	10,5
7,0	2,2	10,3	2,1	10,2	10,3
7,5	1,1	10,0	1,1	9,9	10,0
8,0	-	9,5	-	9,5	9,5

Projektierungshilfe für Emin = 1,0 lx Messebene 0,02 m, Wartungsfaktor WF = 80 %

Abstandstabelle mit Piktogrammscheibe

Deckenmontage
symmetrisch

Montagehöhe in Meter	L1	L2	L3	L4	L5
					
2,0	2,2	5,6	3,1	6,9	6,1
2,5	2,4	6,0	3,6	8,1	7,0
3,0	2,0	6,4	3,8	9,1	7,7
3,5	1,9	6,3	3,9	10,1	8,0
4,0	1,6	5,8	3,8	10,7	8,2
4,5	0,3	5,5	3,7	11,0	8,2
5,0	0,1	5,2	3,6	11,0	7,9
5,5	-	3,7	-	9,2	7,0
6,0	-	3,2	-	8,0	4,3
6,5	-	0,4	-	6,7	3,1
7,0	-	0,2	-	5,6	0,2

Projektierungshilfe für Emin = 1,0 lx Messebene 0,02 m, Wartungsfaktor WF = 80 %